

# ROLL MINOR

## 230 V

CE  
Made in  
Italy

(ITA)

- Riavvolgimento automatico a molla
- Struttura in materiale plastico antiurto
- Staffa di fissaggio orientabile a parete in acciaio verniciato
- Sistema di bloccaggio del cavo alla lunghezza desiderata, facilmente eliminabile ed ispezionabile da parte dell'utente
- Conformi alle norme CE
- Omologati TÜV

(FRA)

- Enroulement automatique à ressort
- Coques en plastique antichoc
- Etrier de fixation murale en acier peint
- Système de blocage du câble à la longueur désirée, facilement éliminable et inspectable de la part de l'utilisateur
- Conformes aux normes CE
- Homologués TÜV

(ENG)

- Automatic spring rewinding
- Plastic outer casing
- Steel swivelling wall bracket
- Ratched stop device easily inspectable and removable by the end user
- CE approved
- TÜV approved

(DEU)

- Kabel-Aufrollautomatik mit Federeantrieb
- Gestell aus schlagfestem Kunststoff
- Schwenkbare Wandhalterung aus lackiertem Stahl
- Sonder-Kabel-Arretierungsvorrichtung, einfach abschaltbar und kontrollierbar
- Konform nach CE-Normen
- TÜV-Zulassung versehen





ENERGY

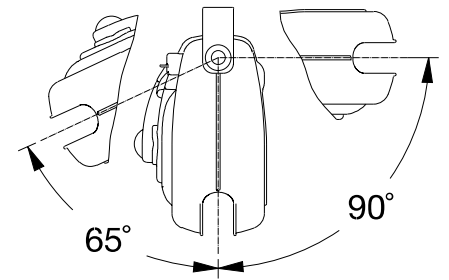
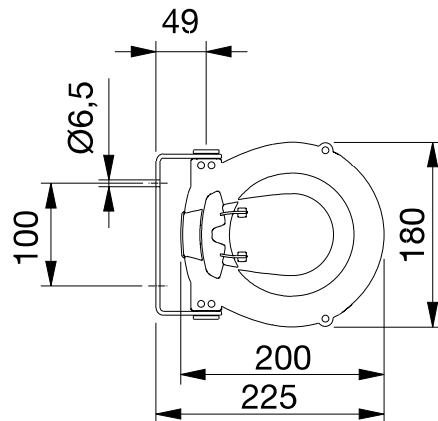
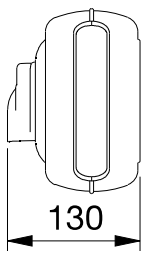



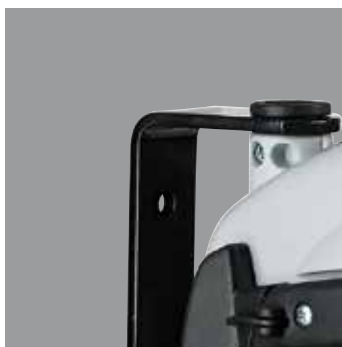















Disgiuntore ripristinabile  
*Dijoncteur à reprise*  
Circuit-braker manually  
restorable  
*Thermostat*



Staffa in acciaio verniciato  
orientabile  
*Patte de fixation murale  
orientable en acier*  
Steel wall swivelling bracket  
*Schwenkbare Halterung  
aus Stahl*



Sistema di bloccaggio del cavo  
a lunghezza desiderata  
*Système de blocage du câble à  
longueur désirée*  
Cable ratcheted stop device  
easily removable  
*Sonder-Kabel  
Arretierungsvorrichtung*

CODE	Codice	800200	800100	800150	800180
					
	Nr. conduttori	2	3	3	3
Nxmm <sup>2</sup>	Sezione	1 mm <sup>2</sup>	1,5 mm <sup>2</sup>	1,5 mm <sup>2</sup>	1,5 mm <sup>2</sup>
	Lunghezza (metri)	7+1 m	5+1 m	5+1 m	5+1 m
CABLE	Tipo cavo	H05VV-F	H05VV-F	H05VV-F	H05VV-F
	Tipo presa/spina	NO	NO	SCHUKO	FRENCH
	Omologazione	/			
	Trasformatore	NO	NO	NO	NO
	Potenza cavo avvolto (Watt)	800W	800W	800W	800W
	Potenza Cavo svolto (Watt)	2000W	2000W	2000W	2000W
	Protezione termica amperometrica	√	√	√	√
	Pezzi pallet	75	75	75	75
	Dimensioni cm	23x20x15	23x20x15	23x20x15	23x20x15
	Peso Kg	1,8 Kg	2 Kg	2 Kg	2 Kg